

E-Tech W 36 three phase



Wall hung electric sealed system boiler.



- > Prepare for a carbon-free future with electric
- > Reduced maintenance – no annual landlord certification
- > Simple installation anywhere in the building due to no flues needed and quiet operation
- > Can provide dual temperature outputs for different circuits such as radiators and underfloor heating (always ensure a safety thermostat is fitted to the underfloor heating circuit)
- > All components integrated in one unit (10 litre expansion tank, pressure gauge, safety valve, low water pressure switch, pump and automatic air vent)
- > Long life high grade incoloy 800 stainless steel heating element
- > Protection from electrical surges due to built-in 3 amp MCB
- > Integrated circulating pump for speed of installation
- > An economical alternative to LPG and Oil for off-grid locations
- > Compatible with different electrical system types
- > Perfect match for use with external cylinders for DHW

ACV UK Ltd

St. David's Drive, St. David's Business Park, Dalgety Bay, Fife, KY11 9PF
uk.sales@acv.com | acv.com

Technical data and dimensions



Name	UNIT	E-Tech W 36 three phase
Part number		A1002094
Output power max (80/60°C)	kW	36.0
Output power min (80/60°C)	kW	18.0
Connection - heating	Ø"	¾
Weight (empty)	kg	45
Max operating temperature	°C	85
Max service pressure heating (primary)	bar	3
Voltage	V	3x400 (+N)
Electrical power requirements	A	52
Space heating energy efficiency class		D
Seasonal space heating efficiency	%	37
Sound power level indoors LWA	dB	15
Number of heating elements		6

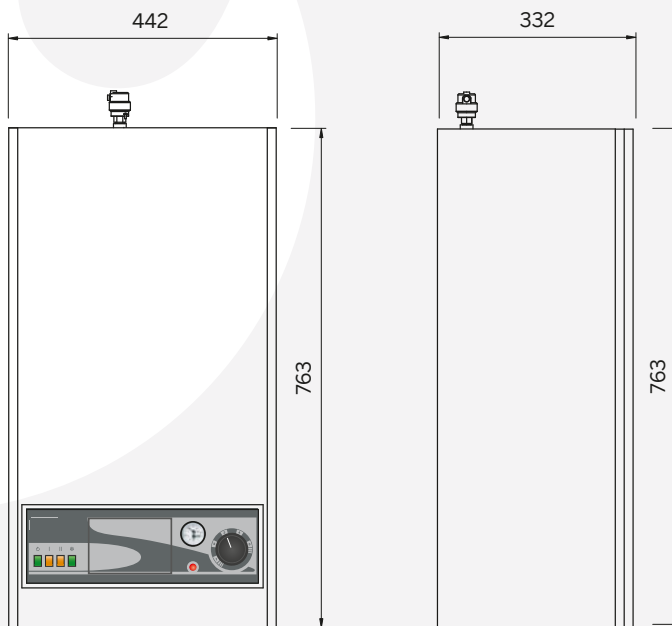

All dimensions in mm.

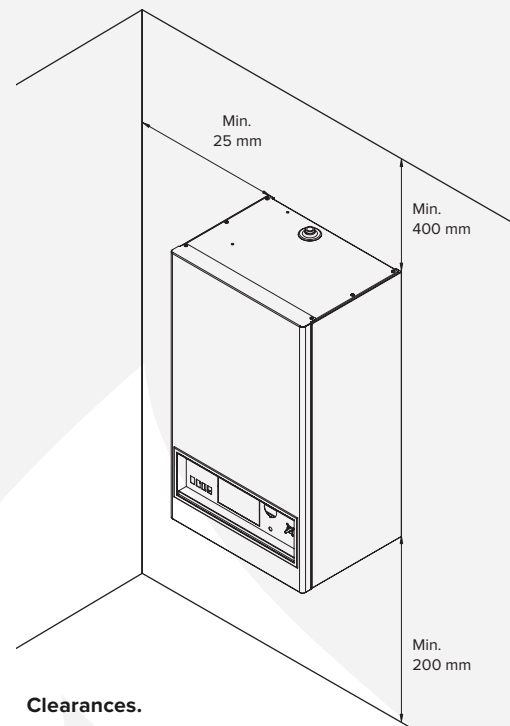

Clearances.